

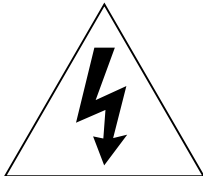

marantz®

Model MA-9S2 User Guide

Monaural Power Amplifier

	CAUTION RISK OF ELECTRIC SHOCK DO NOT OPEN	
CAUTION: TO REDUCE THE RISK OF ELECTRIC SHOCK, DO NOT REMOVE COVER (OR BACK) NO USER-SERVICEABLE PARTS INSIDE REFER SERVICING TO QUALIFIED SERVICE PERSONNEL		

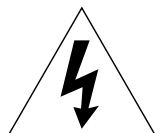

The lightning flash with arrowhead symbol within an equilateral triangle is intended to alert the user to the presence of uninsulated "dangerous voltage" within the product's enclosure that may be of sufficient magnitude to constitute a risk of electric shock to persons.



The exclamation point within an equilateral triangle is intended to alert the user to the presence of important operating and maintenance (servicing) instructions in the literature accompanying the product.

WARNING

**TO REDUCE THE RISK OF FIRE OR ELECTRIC SHOCK,
DO NOT EXPOSE THIS APPLIANCE TO RAIN OR MOISTURE.**

**CAUTION: TO PREVENT ELECTRIC SHOCK, MATCH WIDE
BLADE OF PLUG TO WIDE SLOT, FULLY INSERT.**

**ATTENTION: POUR EVITER LES CHOCS ELECTRIQUES,
INTRODUIRE LA LAME LA PLUS LARGE DE LA FICHE DANS
LA BORNE CORRESPONDANTE DE LA PRISE ET
POUSSER JUSQU'AU FOND.**

IMPORTANT SAFETY INSTRUCTIONS

READ BEFORE OPERATING EQUIPMENT

This product was designed and manufactured to meet strict quality and safety standards. There are, however, some installation and operation precautions which you should be particularly aware of.

1. Read these instructions.
2. Keep these instructions.
3. Heed all warnings.
4. Follow all instructions.
5. Do not use this apparatus near water.
6. Clean only with dry cloth.
7. Do not block any ventilation openings. Install in accordance with the manufacture's instructions.
8. Do not install near any heat sources such as radiators, heat registers, stoves, or other apparatus (including amplifiers) that produce heat.
9. Do not defeat the safety purpose of the polarized or grounding-type plug. A polarized plug has two blades with one wider than the other. A grounding type plug has two blades and a third grounding prong. The wide blade or the third prong are provided for your safety. If the provided plug does not fit into your outlet, consult an electrician for replacement of the obsolete outlet.



10. Protect the power cord from being walked on or pinched particularly at plugs, convenience receptacles, and the point where they exit from the apparatus.
11. Only use attachments/accessories specified by the manufacturer.
12. Use only with the cart, stand, tripod, bracket, or table specified by the manufacturer, or sold with the apparatus. When a cart is used, use caution when moving the cart/apparatus combination to avoid injury from tip-over.
13. Unplug this apparatus during lightning storms or when unused for long periods of time.
14. Refer all servicing to qualified service personnel. Servicing is required when the apparatus has been damaged in any way, such as power-supply cord or plug is damaged, liquid has been spilled or objects have fallen into the apparatus, the apparatus has been exposed to rain or moisture, does not operate normally, or has been dropped.

Additional Safety Information!

- This product should not be placed in a built-in installation such as a bookcase or rack unless proper ventilation is provided or the manufacturer's instructions have been adhered to.
- Apparatus shall not be exposed to dripping or splashing and that no objects filled with liquids, such as vases, shall be placed on the apparatus.
- When the switch is in the OFF position, the apparatus isn't completely switched-off from the MAINS.
- The equipment shall be installed near the Socket-Outlet and shall be easily accessible.

Do Not Touch Hot Spots During and Immediately After Use

During and immediately after use, the MA-9S2 is hot in areas other than the controls and rear panel connection jacks. Do not touch hot spots and especially the top panel. Contact with hot areas can cause burns.

ENGLISH

WARRANTY

For warranty information, contact your local Marantz distributor.

RETAIN YOUR PURCHASE RECEIPT

Your purchase receipt is your permanent record of a valuable purchase. It should be kept in a safe place to be referred to as necessary for insurance purposes or when corresponding with Marantz.

IMPORTANT

When seeking warranty service, it is the responsibility of the consumer to establish proof and date of purchase. Your purchase receipt or invoice is adequate for such proof.

FOR U.K. ONLY

This undertaking is in addition to a consumer's statutory rights and does not affect those rights in any way.

FRANÇAIS

GARANTIE

Pour des informations sur la garantie, contacter le distributeur local Marantz.

CONSERVER L'ATTESTATION D'ACHAT

L'attestation d'achat est la preuve permanente d'un achat de valeur. La conserver en lieu sûr pour s'y reporter aux fins d'obtention d'une couverture d'assurance ou dans le cadre de correspondances avec Marantz.

IMPORTANT

Pour l'obtention d'un service couvert par la garantie, il incombe au client d'établir la preuve de l'achat et d'en corroborer la date. Le reçu ou la facture constituent des preuves suffisantes.

DEUTSCH

GARANTIE

Bei Garantiefragen wenden Sie sich bitte an Ihren Marantz-Händler.

HEBEN SIE IHRE QUITTING GUT AUF

Die Quittung dient Ihnen als bleibende Unterlage für Ihren wertvollen Einkauf. Das Aufbewahren der Quittung ist wichtig, da die darin enthaltenen Angaben für Versicherungswecke oder bei Korrespondenz mit Marantz angeführt werden müssen.

WICHTIG!

Bei Garantiefragen muß der Kunde eine Kaufunterlage mit Kaufdatum vorlegen. Ihre Quittung oder Rechnung ist als Unterlage ausreichend.

CE MARKING



English

The MA9S2/N1G is in conformity with the EMC directive and low-voltage directive.



Français

Le MA9S2/N1G est conforme à la directive EMC et à la directive sur les basses tensions.



Deutsch

Das Modell MA9S2/N1G entspricht den EMC-Richtlinien und den Richtlinien für Niederspannungsgeräte.

English

WARNINGS

- Do not expose the equipment to rain or moisture.
- Do not remove the cover from the equipment.
- Do not insert anything into the equipment through the ventilation holes.
- Do not handle the mains cord with wet hands.
- Do not cover the ventilation with any items such as tablecloths, newspapers, curtains, etc.
- No naked flame sources, such as lighted candles, should be placed on the equipment.
- When disposing of used batteries, please comply with governmental regulations or environmental public instruction's rules that apply in your country or area.
- Make a space of about 0.2 meter around the unit.
- No objects filled with liquids, such as vases, shall be placed on the equipment.
- When the switch is in the OFF position, the equipment is not completely switched off from MAINS.
- The equipment shall be installed near the power supply so that the power supply is easily accessible.

Français

AVERTISSEMENTS

- Ne pas exposer l'appareil à la pluie ni à l'humidité.
- Ne pas essayer de retirer le boîtier de l'appareil.
- Ne rien insérer dans l'appareil par les orifices de ventilation.
- Ne pas manipuler le cordon d'alimentation avec les mains mouillées.
- Ne pas recouvrir les ouïes de ventilation avec un objet quelconque comme une nappe, un journal, un rideau, etc.
- Ne placer aucune source de flamme nue, comme une bougie allumée, sur l'appareil.
- Pour mettre au rebut les piles usées, respecter les lois gouvernementales ou les règlements officiels concernant l'environnement qui s'appliquent à votre pays ou région.

- Veiller à ce qu'aucun objet ne soit à moins de 0,2 mètre des côtés de l'appareil.
- Aucun objet rempli de liquide, un vase par exemple, ne doit être placé sur l'appareil.
- Lorsque l'interrupteur est sur la position OFF, l'appareil n'est pas complètement déconnecté du SECTEUR (MAINS).
- L'appareil sera installé près de la source d'alimentation, de sorte que cette dernière soit facilement accessible.

Deutsch

WARNHINWEISE

- Das Gerät nicht Regen oder Feuchtigkeit aussetzen.
- Die Abdeckung nicht vom Gerät abnehmen.
- Keine Gegenstände durch die Belüftungsschlitze stecken.
- Das Netzkabel nicht mit feuchten oder nassen Händen anfassen.
- Decken Sie die Lüftungsöffnungen nicht mit einem Tischtuch, einer Zeitung, einem Vorhang usw. ab.
- Es dürfen keine Gegenstände mit offener Flamme, wie etwa brennende Kerzen, auf dem Gerät aufgestellt werden.
- Beachten Sie bei der Entsorgung der verbrauchten Batterien alle geltenden lokalen und überregionalen Regelungen.
- Auf allen Geräteseiten muß ein Zwischenraum von ungefähr 0,2 meter vorhanden sein.
- Auf das Gerät dürfen keine mit Flüssigkeiten gefüllte Behälter, wie etwa eine Vase, gestellt werden.
- Wenn der Schalter ausgeschaltet ist (OFF-Position), ist das Gerät nicht vollständig vom Stromnetz (MAINS) abgetrennt.
- Das Gerät sollte in der Nähe einer Netzsteckdose aufgestellt werden, damit es leicht an das Stromnetz angeschlossen werden kann.

TABLE OF CONTENTS

INSTRUCTION FOR USE 2

 FOREWORD2

 EQUIPMENT MAINS WORKING SETTING2

 COPYRIGHT2

 PRECAUTIONS2

ACCESSORIES 2

MAIN FEATURE OF PRODUCT 3

CONNECTIONS 4

 BI-WIRING5

 WIRING THE SPEAKER SYSTEM5

 WIRING SPEAKER CABLE5

 BI-AMP (CONNECTION)7

 WIRING THE SPEAKER SYSTEM7

 COMPLETE BI-AMP CONNECTION9

 BALANCED TERMINAL9

 INSTALLING THE SUPER AUDIO CD MULTI-CHANNEL AUDIO SPEAKERS10

 ITU (INTERNATIONAL TELECOMMUNICATION UNION)10

 WIRING SPEAKER SYSTEM11

NAME AND FUNCTION 12

 FRONT PANEL12

 REAR PANEL12

SPECIFICATION 13

 SPECIFICATION13

 DIMENSIONS13

BLOCK DIAGRAM 13

TROUBLE SHOOTING 14

 ABOUT THE PROTECTIVE CIRCUIT14

MAINTENANCE 14

A NOTE ABOUT RECYCLING



This product's packaging materials are recyclable and can be reused. This product and the accessories packed together are the applicable product to the WEEE directive except batteries. Please dispose of any materials in accordance with your local recycling regulations. When discarding the unit, comply with your local rules or regulations. Batteries should never be thrown away or incinerated but disposed of in accordance with your local regulations concerning chemical wastes.

INSTRUCTION FOR USE

FOREWORD

This section must be read before any connection is made to the mains supply.

EQUIPMENT MAINS WORKING SETTING

Your Marantz product has been prepared to comply with the household power and safety requirements that exist in your area.

MA-9S2/N1G can be powered by 230 V AC only.

MA-9S2/U1G can be powered by 120 V AC only.

COPYRIGHT

Recording and playback of any material may require consent. For further information refer to the following:

- Copyright Act 1956
- Dramatic and Musical Performers Act 1958
- Performers Protection Acts 1963 and 1972
- any subsequent statutory enactments and orders

PRECAUTIONS

The following precautions should be taken when operating the equipment.

■ General Precautions

When siting the equipment ensure that:

- the ventilation holes are not covered;
- air is allowed to circulate freely around the equipment
- it is on a vibration free-surface;
- it will not be exposed to interference from an external source;
- it will not be exposed to excessive heat, cold, moisture or dust;
- it will not be exposed to direct sunlight;
- it will not be exposed to electrostatic discharges

Never place heavy objects on the equipment.

If a foreign body or water does enter the equipment, contact your nearest dealer or service centre.

Do not pull out the plug by pulling on the mains lead, hold the plug.

It is advisable when leaving the house, or during a thunderstorm, to disconnect the equipment from the mains supply.

ACCESSORIES

After opening the cover of the packing box, check that the following accessories are included.

- AC Power Cable

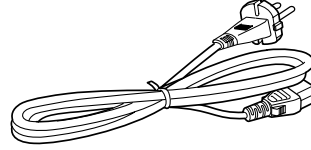

(MA-9S2/N1G)

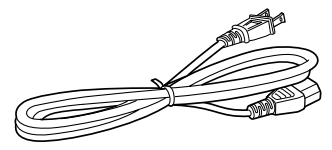

(MA-9S2/U1G)

- Instruction Manual (this Copy)

MAIN FEATURE OF PRODUCT

■ The concept : Instantaneous current delivery capability

Even if amplifier have the same power specifications, their performance may not be the same due to a difference in current delivery capability.

The delivery capability of power amplifier depends on how instantaneous the current supply is.

That's why the power supply for the MA-9S2 was completely revamped to give it a truly instantaneous current supply capability that has been increased three times as much compared to any Marantz product designed before.

■ Fully balanced monaural power amp

To minimize the influence of strong "kick back current" occurring from the loudspeaker system, the circuit for the power amp consists of two amplifiers giving a voltage gain amp of 23dB, in a push-pull balanced construction, for the final buffer amp of 6dB.

■ HDAM SA

The feedback impedance of the Current Feedback circuit was reduced to its minimum to make it faster.

We developed a new Hyper Dynamic Amplifier Modules (HDAM), a separated module operating as a buffer for the amplifier.

■ Choke input system

The power supply of the voltage gain amplifier's adopted choke input system has few ripples and is durable with load changes. This can prevent noise from the amplifier as well as reduce noise from the primary winding, resulting in a clean power supply.

■ Ultra low impedance amplifier

The buffer amplifier's power supply block, which supports the high current delivery capability, uses a capacitance input system to realize very low impedance.

The new developed toroidal power transformer, the low impedance electrolytic capacitors, the very large gauge internal wiring, and the thick pattern PWB all contribute in supplying the required power.

CONNECTIONS

Connection 1 Stereo Bi-wiring Connection

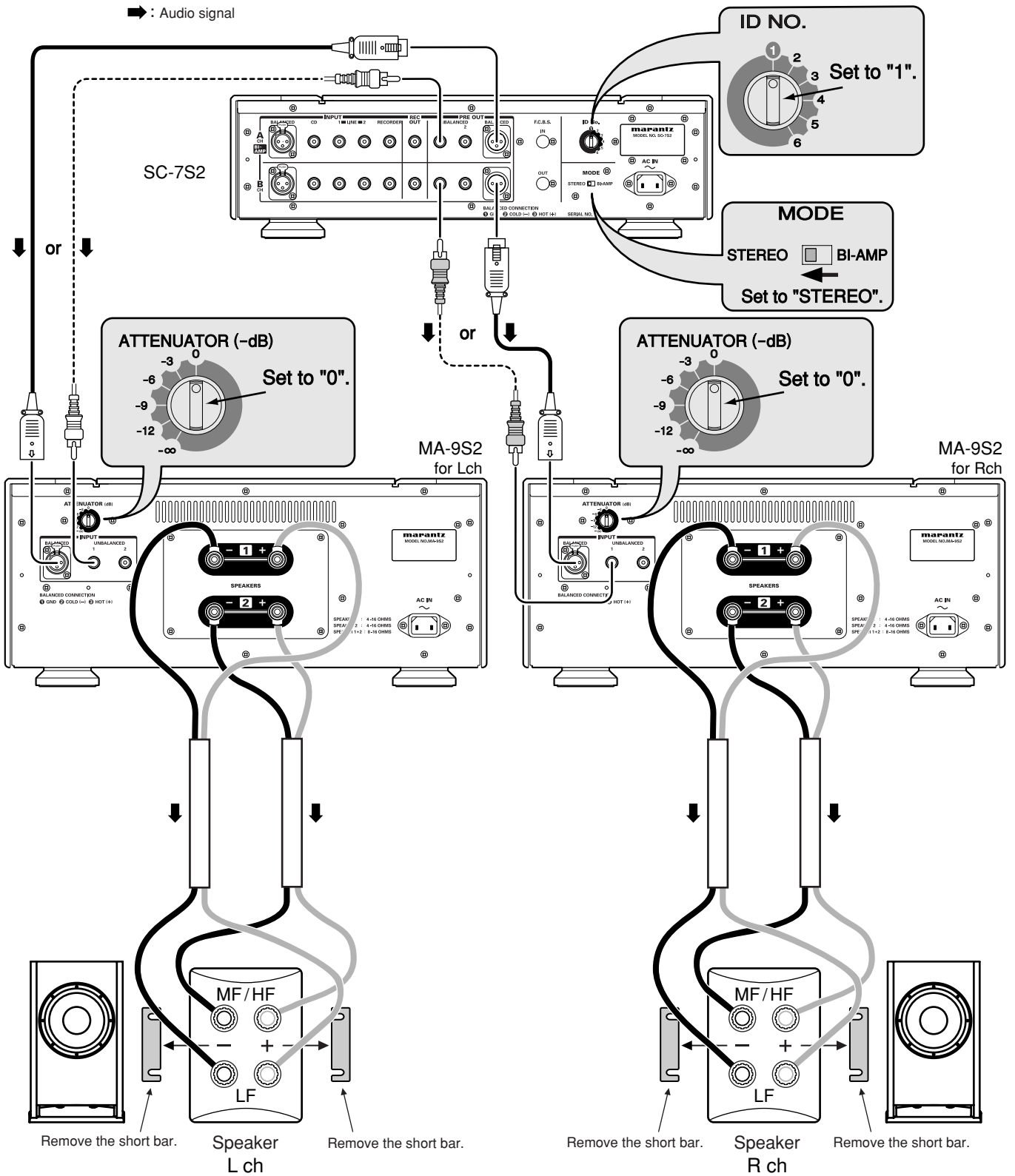

This connection can have options i.e. You may connect the units using either balanced or unbalanced cables.

CONNECTIONS

Connection 1 - 4 are recommended by Marantz for the SC-7S2 with Marantz MA-9S2s.
All Connections are based on speaker systems that are capable of Bi-Wiring.
Please read the instruction manual for the SC-7S2 for use. Name and Function → P12

BI-WIRING

The method is to improve sound quality, by connecting speaker cable respectively to each terminal for Bass and Mid/High speakers. This method will reduce interference caused by the bass speaker and the Mid/High speaker unit being powered by the same amplifier.

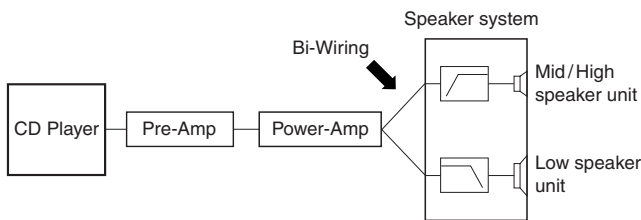

WIRING THE SPEAKER SYSTEM

■ Speaker system doesn't comply with the Bi-Wiring

Please connect either of the speaker terminals 1 or 2. And please use a speaker system whose impedance is for 4 - 16Ω. If impedance is lower than 4Ω, the protection circuit will be engaged during play. This will result in no output of the Amplifier.

■ Speaker system comply with the Bi-Wiring

Please connect both of the speaker terminals 1 and 2. And please use a speaker system whose impedance is for 4 - 16Ω. If impedance is lower than 4Ω, protection circuit will be engaged during play. This will result in no output of the Amplifier.

■ Polarity of Speaker output terminal

Speaker terminals have positive (+ : Red) and negative (- : White) polarity and speaker wires also have (+ & -) polarity. In wiring, be sure to connect the terminals with the same polarity (+ and +, - and -).

CAUTION:

When connecting two pairs of speaker systems simultaneously, the impedance of each speaker system should be no less than 8 ohm .

Connecting a speaker system with a lower impedance than 8 ohm may activate the protection circuitry and make normal stereo reproduction impossible.

WIRING SPEAKER CABLE

- Be careful not to short circuit in wiring speaker cables.
- Peel off the coring of speaker cable as shown below.

Approx. 1 cm

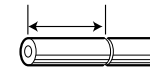

Cut the coring of cable.



Peel off the edge of cable.

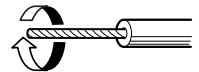

Twist conductors.

- Wiring with speaker cable.

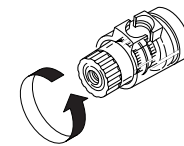

Turn counter-clockwise to loosen.

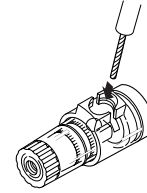

Insert conductor of cable.

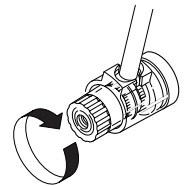

Turn clockwise to tighten.

- Wiring with "Y" style terminal

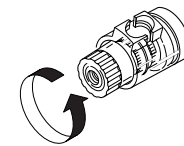

Turn counter-clockwise to loosen.

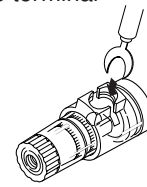

Insert conductor.

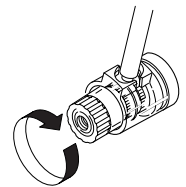

Turn clockwise to tighten.

CONNECTIONS

Connection 2 Stereo Bi-Amp connection. (Make sure your speakers are designed for Bi Amp capabilities)

➡ : Audio signal

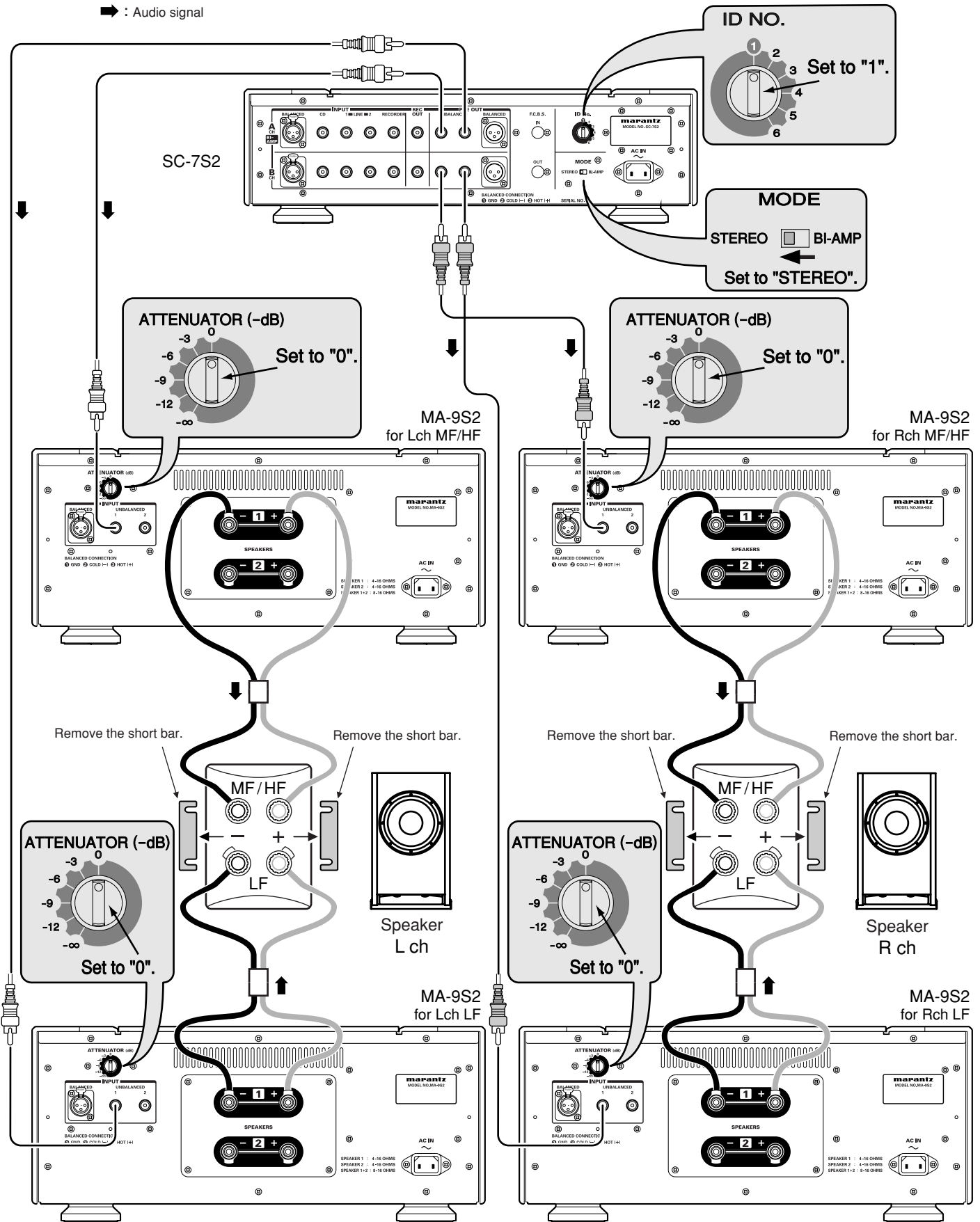

CONNECTIONS

Enhance connection 1 to Bi-Amp connection, and drive the bass speaker and Mid / High Frequency speakers with separate power Amplifiers.

BI-AMP (CONNECTION)

The benefits of Bi-Wiring; drive the bass speaker and Mid / High speakers with separate power Amplifiers. Bi-Amping will lessen the burden of Power Amp impedance, so that back electromotive force between the Low and Mid/High signal can be lessened. We can expect drastic improvement of sound quality.

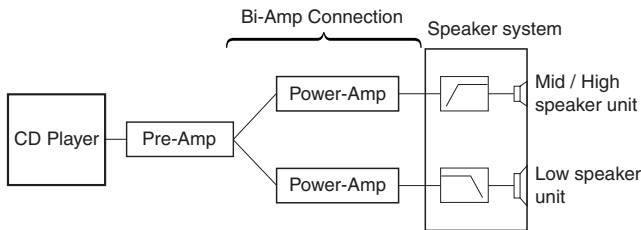

Caution:

In the event of this connection (Control Amp SC-7S2 is <Stereo>mode), SC-7S2 and MA-9S2 can be wired by Unbalanced only.

WIRING THE SPEAKER SYSTEM

- Please remove short bar of speaker terminal.
If short bar has not been remove, it will damage the power amplifier.
- Please use speaker systems whose impedance are for 4 - 16Ω.
If impedance is lower than 4Ω, the protection circuit will be engaged during play.
- Make sure your speakers are designed for Bi Amp capabilities. If they don't the protection circuit will be engaged and there will be no output. Or it will damage the power amplifier.

CONNECTIONS

Connection 3 Stereo complete Bi-Amp connection.
(Make sure your speakers are designed for Bi Amp capabilities)

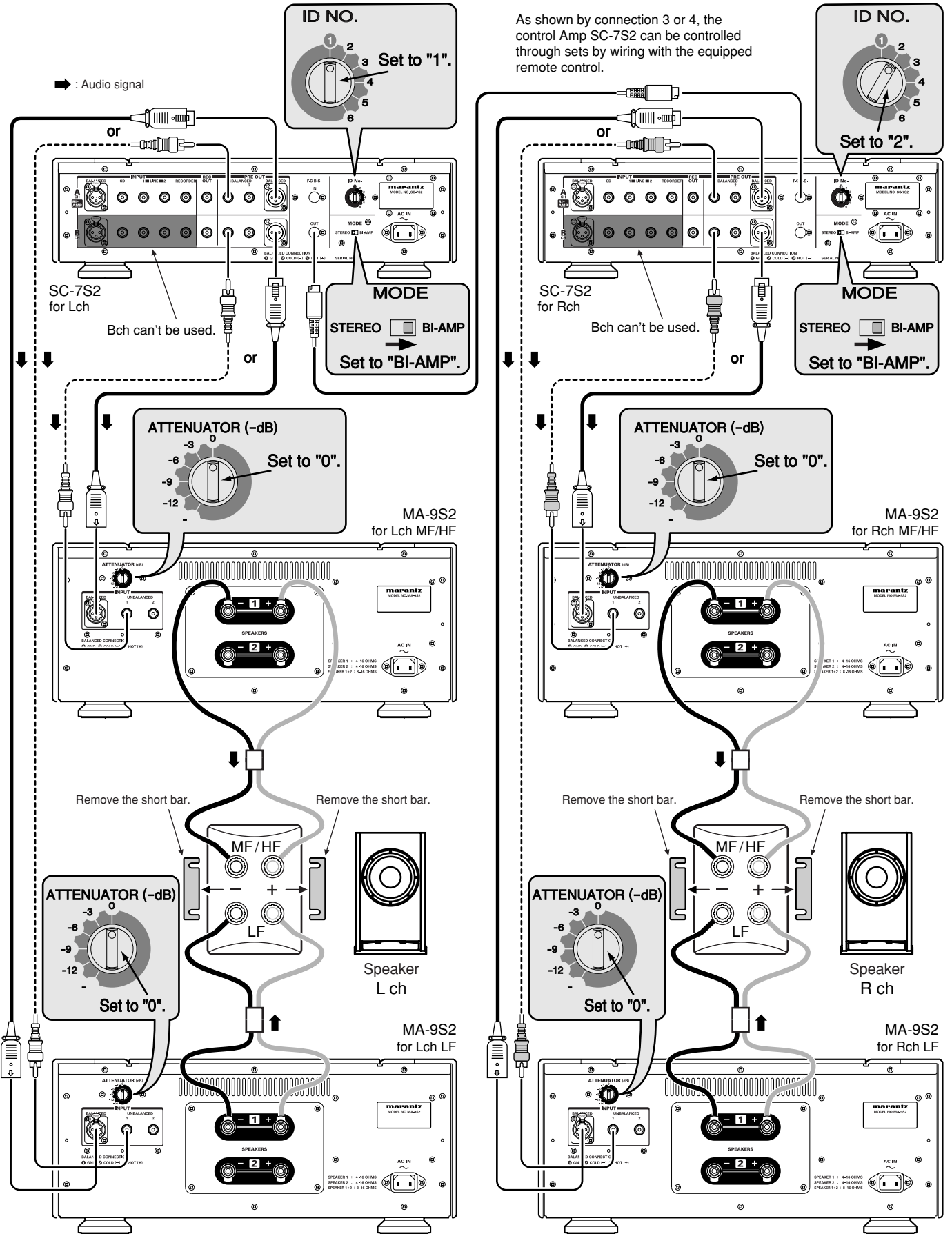

CONNECTIONS

This connection can have options i.e. You may connect the units using either balanced or unbalanced cables. But, you have to use the same cables per SC-7S2.

COMPLETE BI-AMP CONNECTION

Enhance connection 2, by having one more control Amp. SC-7S2, this is a Complete Bi-Amp connection which separates Mid / High (MF/HF) signal and Low (LF) signal from Pre-Amp section.

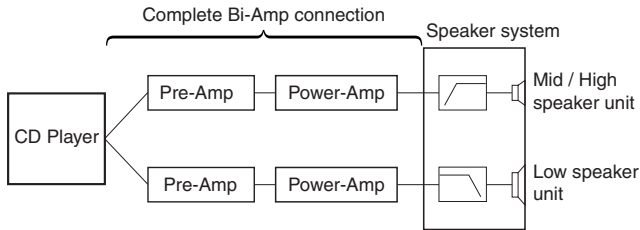

In this event, SC-7S2 is using as Monaural Amps. And separate Left/Right channels from the output terminal of CD players. As a result, influences between L channel and R channel Mid / High signal and Low signal will be eliminated. A maximum of 6 SC-7S2s, can be connected to each other, via remote cables.

Caution:

In the event of setting mode switch as <Bi-Amp>, B channel input terminals can't be used.

BALANCED TERMINAL

- ① The balanced output connector uses a XLR connector.
- ② The XLR connector is internally wired in either of the following two systems.

1. USA system (Pin 2 = COLD, Pin 3 = HOT)

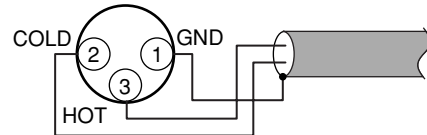

2. European system (Pin 2 = HOT, Pin 3 = COLD)

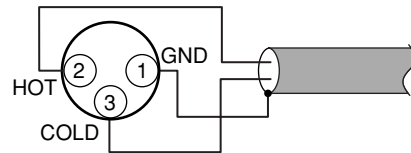

- ③ The MA-9S2 uses the USA system of 1. When a preamp or main amplifier adopting the European system is connected using a cable with XLR balanced connectors, the reproduced signal may be inverted of phase. In this case, correct the wiring of the one of the XLR connectors on the extremities of the cable to the USA system by exchanging the connections of pins 2 and 3. This will make it possible to play the signal with the correct phase.

CONNECTIONS

INSTALLING THE SUPER AUDIO CD MULTI-CHANNEL AUDIO SPEAKERS

In order to enjoy Super Audio CD multi-channel sound with the best possible acoustics, it is recommended that the speaker systems be laid out in compliance with the ITU-R BS.775-1 recommendation which is a standard formulated by the International Telecommunication Union (ITU).

Super Audio CD multi-channel discs are recorded and mixed in such a way that they will achieve the optimum effects when the speaker systems are laid out as per the ITU-R BS.775-1 recommendation.

- On Super Audio CD multi-channel discs, the music signals are basically recorded using 5 channels (or 3, 4 or 6 channels in some cases). In some instances, however, LFE (for the sub woofer) is recorded as a sixth channel. Each disc indicates how many channels have been recorded on it.
- The basic settings are 3 speakers for front and 2 for back since multi-channel discs have basically 5 channels. The 2-front, 1-center, and 2-surround speakers should be set on the circle from the listening point as shown below. When you use different sizes of speakers, please adjust the volume balances.
- The location of the sub-woofer in the picture is just to you a patten of settings. Sub-woofer can be located any place in your room. (See the users manual of your sub-woofer.)

ITU (INTERNATIONAL TELECOMMUNICATION UNION)

The ITU is a special organization of the United Nations. It consists of a number of organs, one of which is the Radio Broadcasting Section.

ITU-R BS is the recommendation which consists of standards relating to broadcasting (audio) operations, one of which is the ITU-R BS.775-1 which governs "multi-channel stereo sound systems."

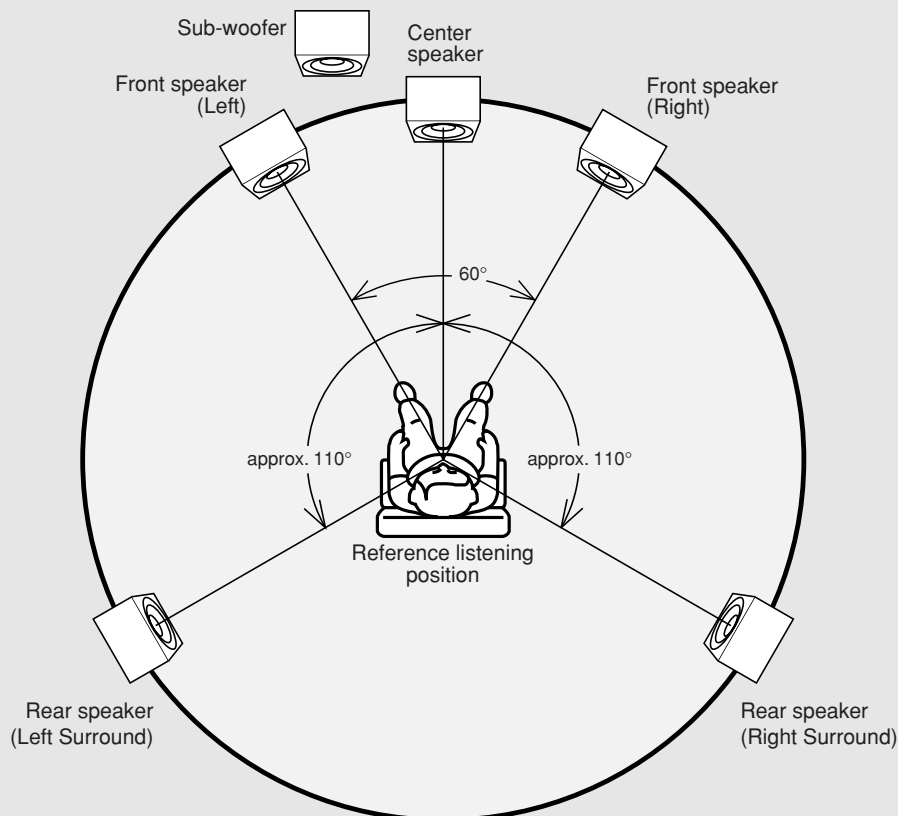

CONNECTIONS

Connection 4 5.1ch multi-channel connection

Below is the standard connection for a Multi-channel sound source. This will enable you to experience the high quality sound acoustic for the professional Home theatre and pure multi channel audio. The complete 5.1 system is controlled using 3 SC-7S2 Stereo Control Amplifiers.

- <3 unit of SC-7S2 + 10 unit of MA-9S2 + Active sub-woofer>
- <6 unit of SC-7S2 + 10 unit of MA-9S2 + Active sub-woofer>

This connection can have options i.e. You may connect the units using either balanced or unbalanced cables. But, you have to use the same cables per SC-7S2.

WIRING SPEAKER SYSTEM

Please refer to <Wiring speaker system> p.5 of connection 1.

Caution

- If you use an Active (powered) sub-woofer for LFE, please refer to the Users manual of the Active sub-woofer for set up instructions. LFE (Low Frequency Effect) is the channel for Low Frequency only.
- If you use a Passive sub-woofer for LFE, a Monaural power Amp such as the MA-9S2 can be used to drive it.

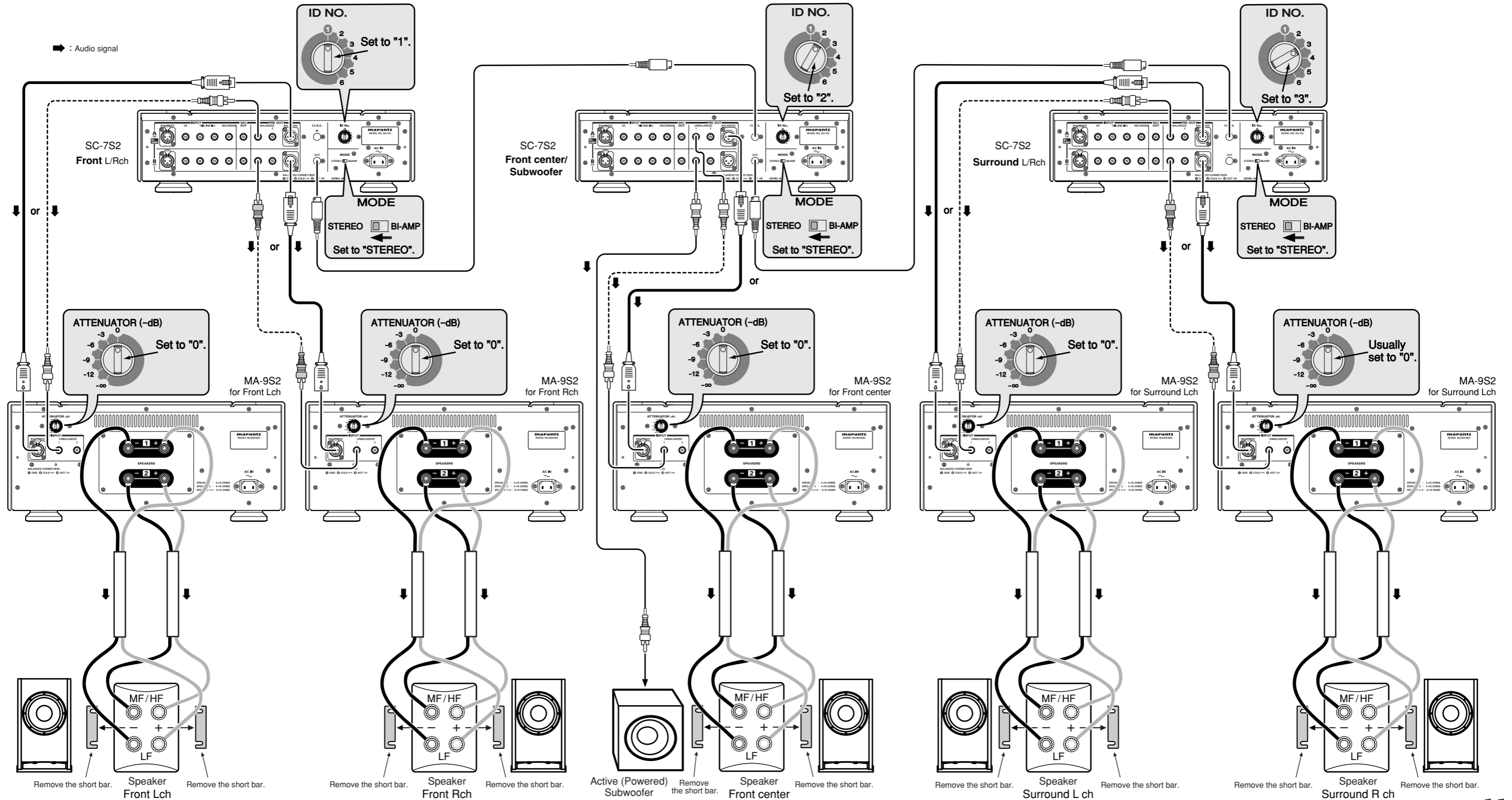

NAME AND FUNCTION

FRONT PANEL

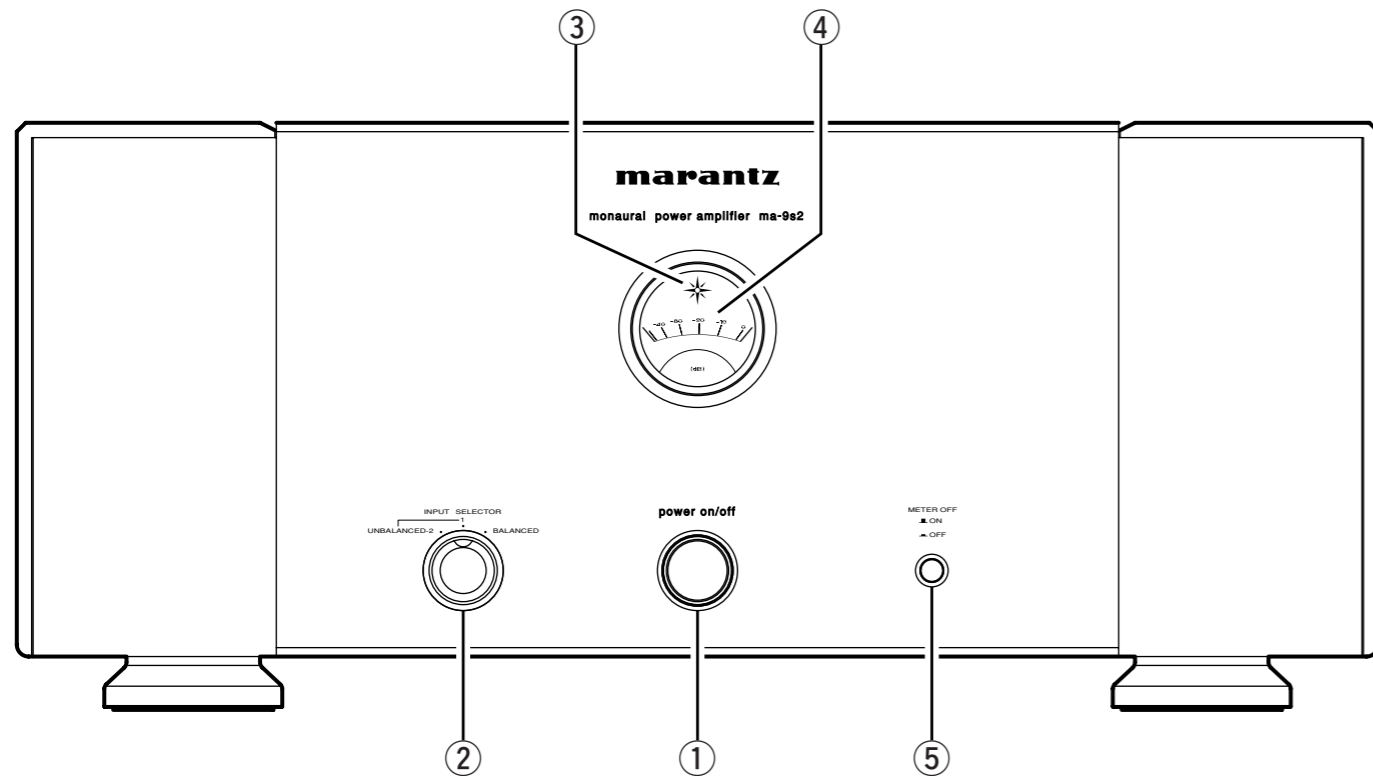

① Power switch

Press the power switch to turn the power on/off. When the power is on, the power indicator ③ will be illuminated.

② Input selector

This knob is used to select the input source from the Pre-Amp.

③ Power indicator

The power indicator is illuminated while the power switch is on.

④ Level meter

The meter is used to check the output power.

Meter indication vs Output power

Indicated level (dB)	8ΩLoad(W)	4ΩLoad(W)
0	300	600
-10	30	60
-20	3	6
-30	0.3	0.6
-40	0.03	0.06

⑤ Meter off switch

This switch is used to turn on/off the level meter and the internal light of the level meter.

REAR PANEL

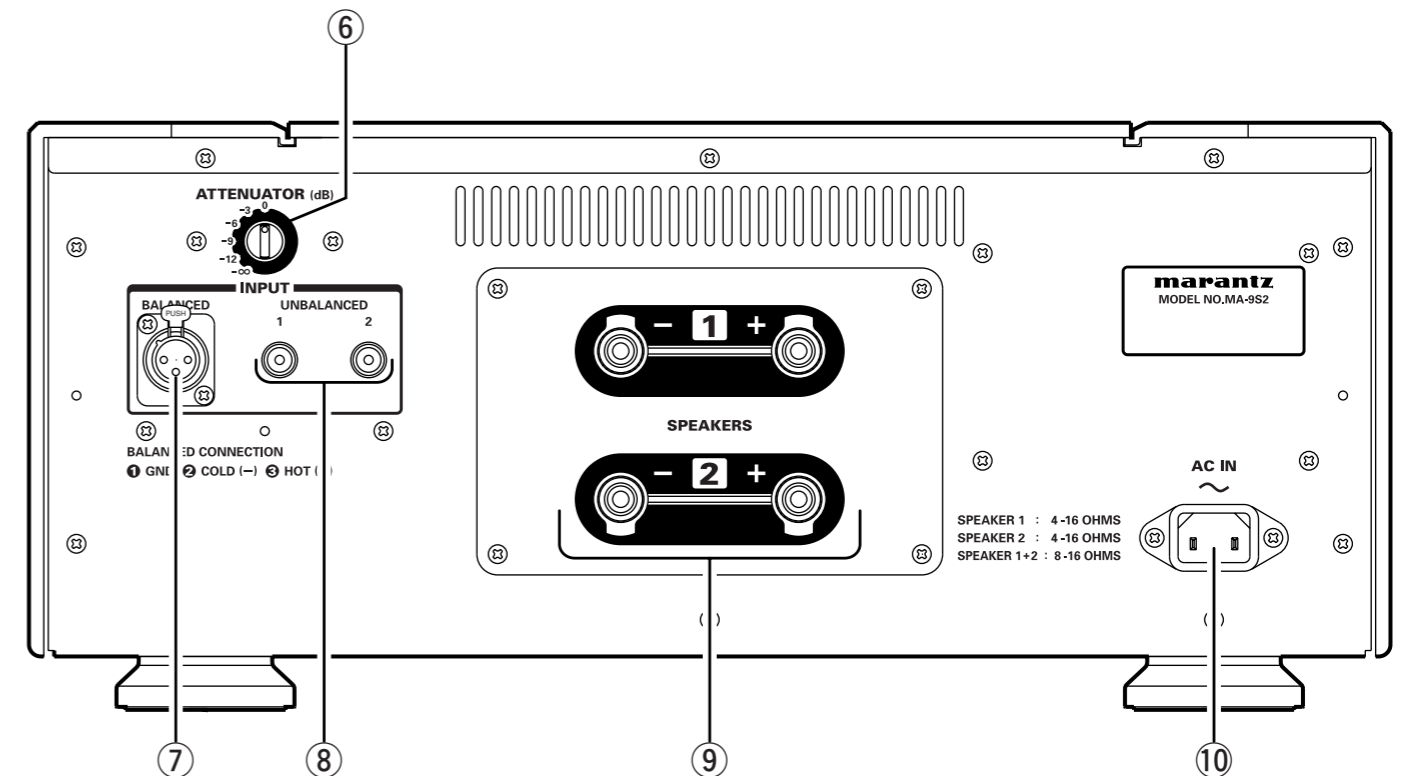

⑥ ATT (Attenuator)

The knob is used to attenuate the input level. Initial setup is 0 dB.

⑦ Balanced input terminal

Connect to the Balanced output terminal of the Pre-Amp.

⑧ Unbalanced input terminal 1, 2

Connect to the Unbalanced output terminal of the Pre-Amp.

⑨ Speaker output terminal

Connect your speaker system to these terminals. Speaker cable wiring → p.5

⑩ AC IN socket

Connect to a household power outlet.

SPECIFICATION

SPECIFICATION

Power Output (20Hz - 20kHz) 300W (8Ω Load)
 600W (4Ω Load)
T.H.D. (20Hz - 20kHz, 8Ω Load) 0.01%
Frequency response (1W, 8Ω Load) 3 Hz - 150 kHz (+0, -3dB)
Dumping factor 200 (20Hz - 20kHz, 8Ω Load)
Input sensitivity/ Input impedance	
 1.7V / 20kΩ (Balanced)
 1.7V / 20kΩ (Unbalanced)
S/N (IHF-A)	
 123 dB (Balanced)
 123 dB (Unbalanced)
Attenuation 0, -3, -6, -9, -12, -∞ dB
Power requirement (MA-9 S2/N1G) AC 230V 50Hz
	(MA-9S2/U1G) AC 120V 60Hz
Power Consumption (MA-9S2/N1G) 500 W
	(MA-9S2/U1G) 500 W
	1200 W (Output: 4Ω, 600W)
Dimensions	
 Width 459 mm
 Height 198 mm
 Depth 451 mm
Weight 37.4 kg

DIMENSIONS

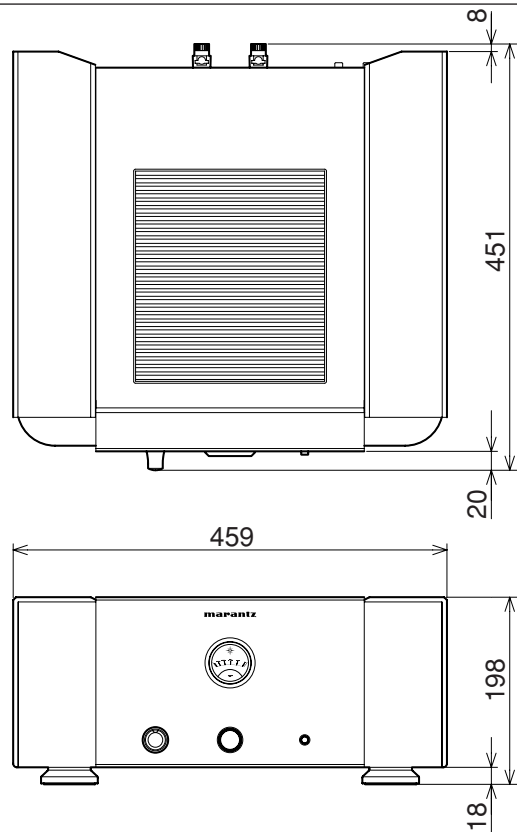

Unit : mm

BLOCK DIAGRAM

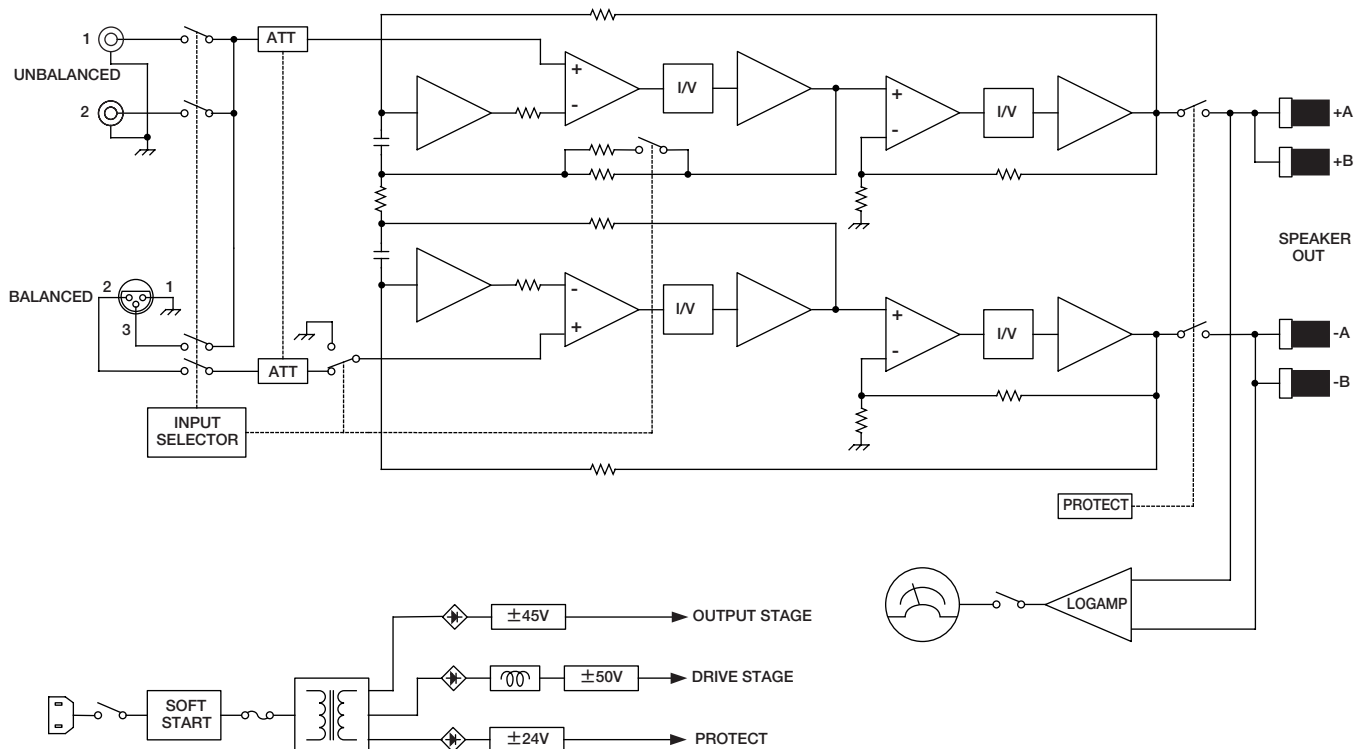

TROUBLE SHOOTING

Should faults occur, in many cases it is not necessary to consult your dealer or a Marantz technical service department.

On the basis of the following checks you will be able to rectify a number of faults yourself without difficulty.

If the fault cannot be remedied after the following checks, please consult your dealer or nearest Marantz service agent.

■ The unit does not turn ON

1. Is the power cable securely plugged into an AC outlet?

■ Sound is not coming from the speakers

1. Has the wrong input source been selected with the INPUT SELECTOR on the front panel?
2. Is the ATTENUATOR switch set to ∞ on the rear panel?
3. Are speaker cables properly connected to the speaker system?
4. Is the connection cable properly connected to the control (pre) amplifier?
5. Is the control (pre) amplifier or input source wrongly set?
6. Are you using the player in the wrong way?
7. The protective circuit of this unit may have worked. Shut power OFF, wait 1 minute or more, then reactivate the power.

ABOUT THE PROTECTIVE CIRCUIT

This unit incorporates a protective circuit that protects the amplifier circuit and speaker system against damage. If the protective circuit works, the power indicator in the meter flashes, and sound is muted (no sound). This protective circuit works in the following cases.

■ At power ON

It takes approximately 8 seconds for the amplifier circuit to stabilize after the power is turned on, during which time the protective circuit works and sound is muted (no sound). Also during this time, the power indicator in the meter flashes.

Once the amplifier circuit has stabilized, the protective circuit is released, and sound can be heard.

■ If overcurrent flows to the amplifier circuit (Overcurrent protection)

If overcurrent flows to the amplifier circuit because of excessive signal input or if the unit is used with speakers of less than 4 Ω impedance connected to it, overcurrent is detected and the protective circuit engage. The protective circuit also works if the speaker cables are accidentally shorted.

The power indicator in the meter flashes when the protective circuit works, so check the power indicator.

If it has worked, shut power OFF, wait 1 minute or more, then reactivate the power.

■ If the amplifier overheats

In the following cases, the amplifier will overheat and the protective circuit will work .

- If the unit is used with the ventilation blocked or obstructed
- If speakers of less than 4 Ω impedance are used
- If the unit is used for an extended period of time under excessive signal input.

MAINTENANCE

The section describes the care and maintenance tasks that must be performed to optimize the operation of your Marantz equipment.

■ Cleaning of equipment external surfaces

The exterior finish of your unit will last indefinitely with proper care and cleaning. Never use scouring pads, steel wool, scouring powders or harsh chemical agents (e.g., lye solution), alcohol, thinner, benzene, insecticide or other volatile substances as these will mar the finish of the equipment. Likewise, never use cloths containing chemical substances. If the equipment get dirty, wipe the external surfaces with a soft, lint-free cloth.

If the equipment becomes heavily soiled:

- dilute some washing up liquid in water, in a ratio of one part detergent to six parts water.
- dip a soft, lint free in the solution and wring the it is damp.
- wipe the equipment with the damp cloth.



- dry the equipment by wiping it with a dry cloth.

■ Repairs

Only the most competent and qualified service technicians should be allowed to service the factory-trained warranty station personnel have the knowledge and special facilities needed for repair and calibration of this precision equipment. After the warranty period has expired, repairs will be performed for a charge if the equipment can be returned to normal operation. In the event of difficulty, refer to your dealer or write directly to the nearest location to you that is listed on the Marantz Authorized Service Station list. If writing, please include the model and serial number of the equipment together with a full description of what you think is abnormal about the equipment's behaviour.

www.marantz.com

You can find your nearest authorized distributor or dealer on our website.

marantz[®] is a registered trademark.